

SLB65R280E7

N-Channel Power MOSFET

General Description

This Power MOSFET is produced using Msemitek's Advanced Super-Junction technology.

This advanced technology has been especially tailored to minimize conduction loss, provide superior switching performance, and withstand high energy pulse in the avalanche and commutation mode.

These devices are well suited for AC/DC power conversion in switching mode operation for higher efficiency.

Features

- 15A, 650V, $R_{DS(on)typ} = 0.28\Omega @ V_{GS} = 10V$
- Low gate charge (typical 19.6nC)
- Lower Gate Resistance
- 100% Avalanche Tested
- Pb-free and RoHS Compliant

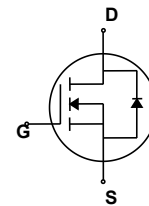
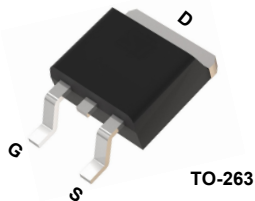

Absolute Maximum Ratings

$T_C = 25^\circ\text{C}$ unless otherwise noted

Symbol	Parameter	SLB65R280E7	Units
V_{DSS}	Drain-Source Voltage	650	V
I_D	Drain Current - Continuous ($T_C = 25^\circ\text{C}$) - Continuous ($T_C = 100^\circ\text{C}$)	15	A
		8	A
I_{DM}	Drain Current - Pulsed (Note 1)	37.5	A
V_{GSS}	Gate-Source Voltage	± 30	V
EAS	Single Pulsed Avalanche Energy (Note 2)	710	mJ
I_{AR}	Avalanche Current (Note 1)	3.0	A
E_{AR}	Repetitive Avalanche Energy	1.11	mJ
dv/dt	Peak Diode Recovery dv/dt (Note 3)	20	V/ns
	MOSFET dv/dt	100	
P_D	Power Dissipation ($T_C = 25^\circ\text{C}$) - Derate above 25°C	30	W
		0.24	W/ $^\circ\text{C}$
T_J, T_{STG}	Operating and Storage Temperature Range	-55 to +150	$^\circ\text{C}$
T_L	Maximum lead temperature for soldering purposes, 1/8" from case for 5 seconds	300	$^\circ\text{C}$

* Drain current limited by maximum junction temperature.

Thermal Characteristics

Symbol	Parameter	SLB65R280E7	Units
$R_{\theta JC}$	Thermal Resistance, Junction-to-Case	4.1	$^\circ\text{C}/\text{W}$
$R_{\theta JS}$	Thermal Resistance, Case-to-Sink Typ.	--	$^\circ\text{C}/\text{W}$
$R_{\theta JA}$	Thermal Resistance, Junction-to-Ambient	62.5	$^\circ\text{C}/\text{W}$

Package Marking

Part Number	Top Marking	Package	Packing Method	MOQ	QTY
SLB65R280E7	SLB65R280E7	TO-263	Tape	800	4000

Electrical Characteristics

$T_C = 25^\circ\text{C}$ unless otherwise noted

Symbol	Parameter	Test Conditions	Min	Typ	Max	Units
--------	-----------	-----------------	-----	-----	-----	-------

Off Characteristics

BV _{DSS}	Drain-Source Breakdown Voltage	$V_{GS} = 0\text{ V}, I_D = 250\text{ mA}$	650	--	--	V
		$V_{GS} = 0\text{ V}, I_D = 0.25\text{ uA}, T_J = 150^\circ\text{C}$	650	--	--	
I _{DSS}	Zero Gate Voltage Drain Current	$V_{DS} = 600\text{ V}, V_{GS} = 0\text{ V}$	--	--	1	uA
		$V_{DS} = 480\text{ V}, T_C = 125^\circ\text{C}$	--	2	--	
I _{GSSF}	Gate-Body Leakage Current, Forward	$V_{GS} = 30\text{ V}, V_{DS} = 0\text{ V}$	--	--	100	nA
I _{GSSR}	Gate-Body Leakage Current, Reverse	$V_{GS} = -30\text{ V}, V_{DS} = 0\text{ V}$	--	--	-100	nA

On Characteristics

V _{GS(th)}	Gate Threshold Voltage	$V_{DS} = V_{GS}, I_D = 250\text{ uA}$	2.5	--	4.5	V
R _{DS(on)}	Static Drain-Source On-Resistance	$V_{GS} = 10\text{ V}, I_D = 7.5\text{ A}$	--	238	280	mΩ
R _g	Gate resistance	F=1MHZ	--	1.1	--	Ω

Dynamic Characteristics

C _{iss}	Input Capacitance	$V_{DS} = 400\text{ V}, V_{GS} = 0\text{ V},$ $f = 1\text{ MHz}$	--	780	--	pF
C _{oss}	Output Capacitance		--	23	--	pF
C _{o(tr)}	Time Related Output Capacitance	$V_{DS} = 0\text{ V to } 400\text{ V}, V_{GS} = 0\text{ V}$	--	300	--	pF
C _{o(er)}	Energy Related Output Capacitance		--	37	--	pF

Switching Characteristics

t _{d(on)}	Turn-On Delay Time	$V_{DS} = 400\text{ V}, I_D = 5.3\text{ A}$ $V_{GS} = 10\text{ V}, R_G = 10\ \Omega$ See Figure 13	--	7.6	--	ns
t _r	Turn-On Rise Time		--	6.7	--	ns
t _{d(off)}	Turn-Off Delay Time		--	38.2	--	ns
t _f	Turn-Off Fall Time		--	8.4	--	ns
Q _g	Total Gate Charge	$V_{DS} = 400\text{ V}, I_D = 5.3\text{ A},$ $V_{GS} = 10\text{ V}$	--	19.6	--	nC
Q _{gs}	Gate-Source Charge		--	3.7	--	nC
Q _{gd}	Gate-Drain Charge		--	9.7	--	nC

Drain-Source Diode Characteristics and Maximum Ratings

I _S	Maximum Continuous Drain-Source Diode Forward Current	--	--	12.5	A	
I _{SM}	Maximum Pulsed Drain-Source Diode Forward Current	--	--	37.5	A	
V _{SD}	Drain-Source Diode Forward Voltage	$V_{GS} = 0\text{ V}, I_S = 5.3\text{ A}$	--	--	1.2	V
t _{rr}	Reverse Recovery Time	$V_{DD} = 400\text{ V}, I_S = 5.3\text{ A},$ $di_F / dt = 100\text{ A/us}$	--	234	--	ns
Q _{rr}	Reverse Recovery Charge		--	2.2	--	uC

※Notes:

1. Repetitive rating: pulse-width limited by maximum junction temperature.
2. $L = 79\text{ mH}, I_{AS} = 3\text{ A}, R_G = 25\ \Omega$, starting $T_J = 25^\circ\text{C}$.
3. $I_{SD} \leq 5.3\text{ A}, di/dt \leq 100\text{ A/us}, V_{DD} \leq 400\text{ V}$, starting $T_J = 25^\circ\text{C}$.

Typical Characteristics

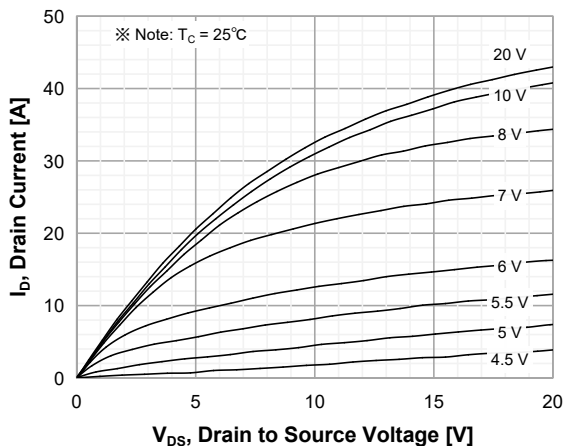

Figure 1. On-Region Characteristics

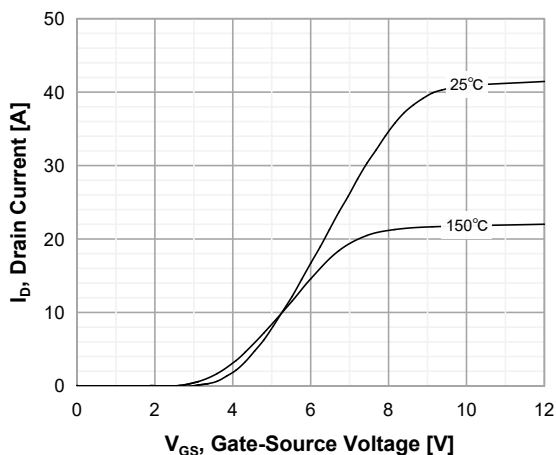

Figure 2. Transfer Characteristics

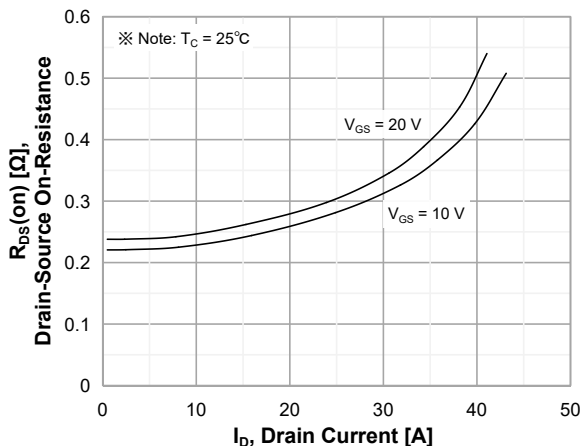

Figure 3. On-Resistance Variation vs Drain Current and Gate Voltage

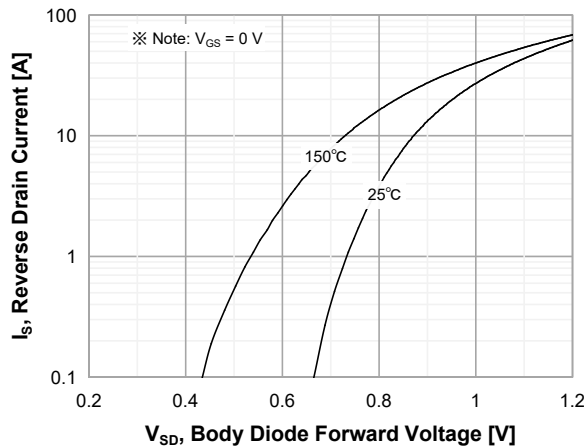

Figure 4. Body Diode Forward Voltage Variation with Source Current and Temperature

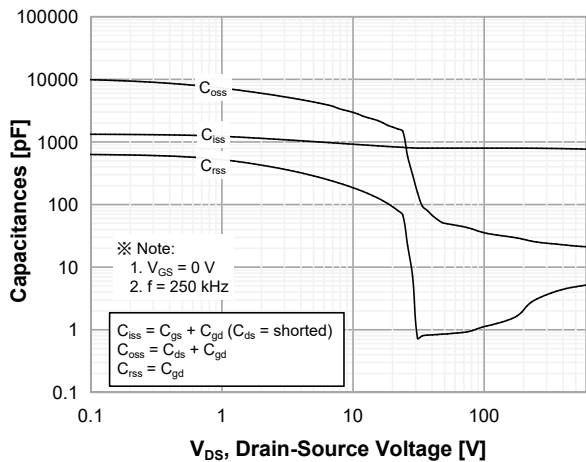

Figure 5. Capacitance Characteristics

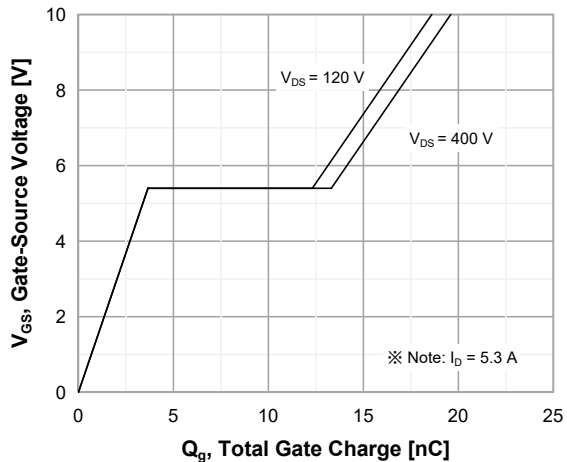

Figure 6. Gate Charge Characteristics

Typical Characteristics (Continued)

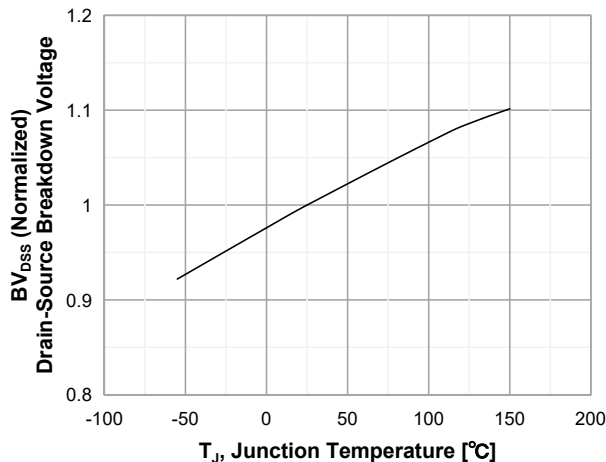

Figure 7. Breakdown Voltage Variation vs Temperature

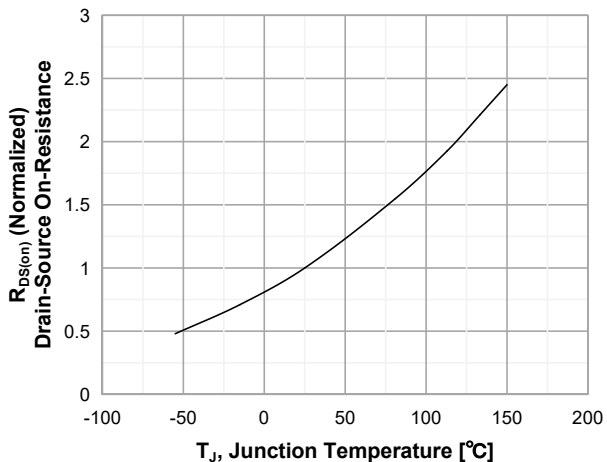

Figure 8. On-Resistance Variation vs Temperature

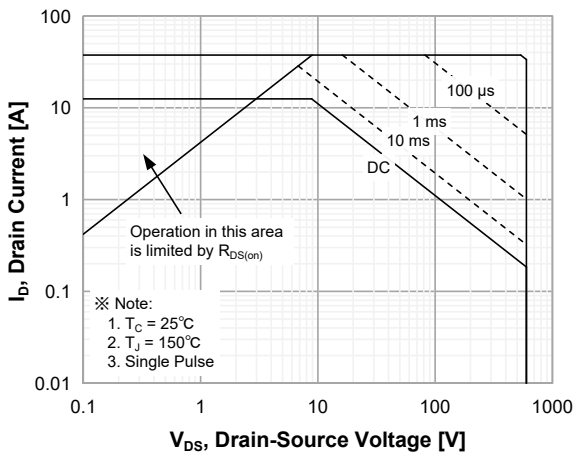

Figure 9. Maximum Safe Operating Area

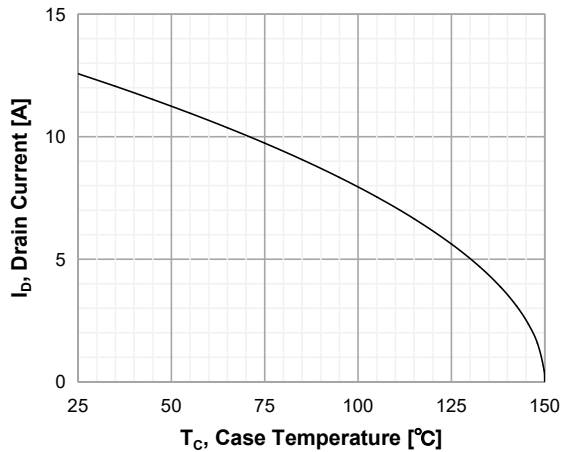

Figure 10. Maximum Drain Current vs Case Temperature

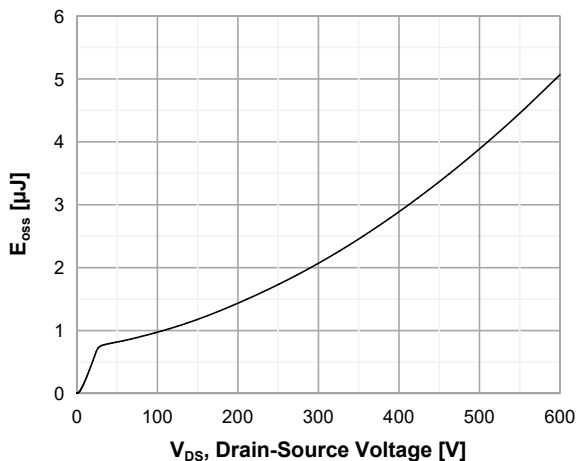

Figure 11. E_{OSS} vs. Drain to Source Voltage

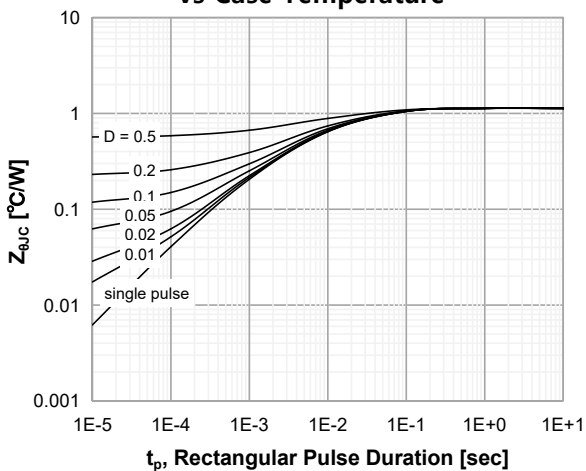
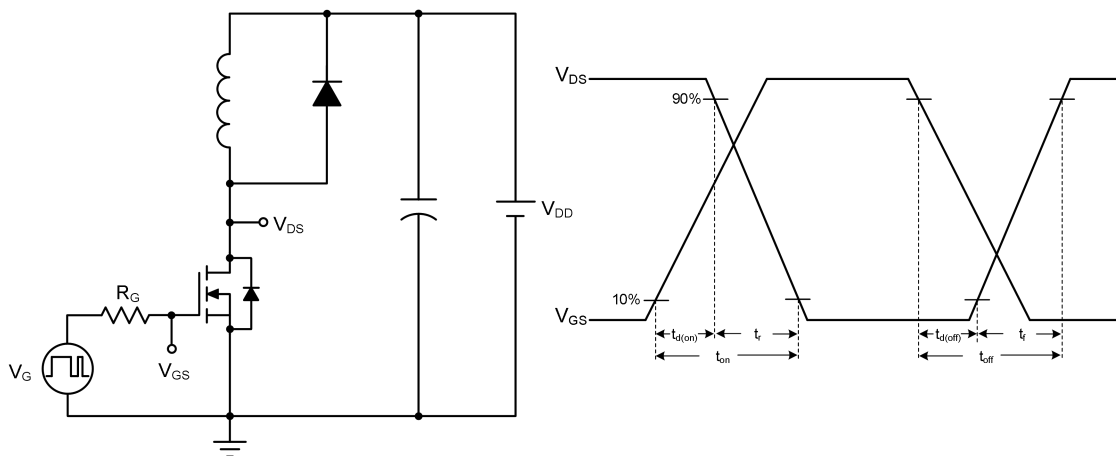
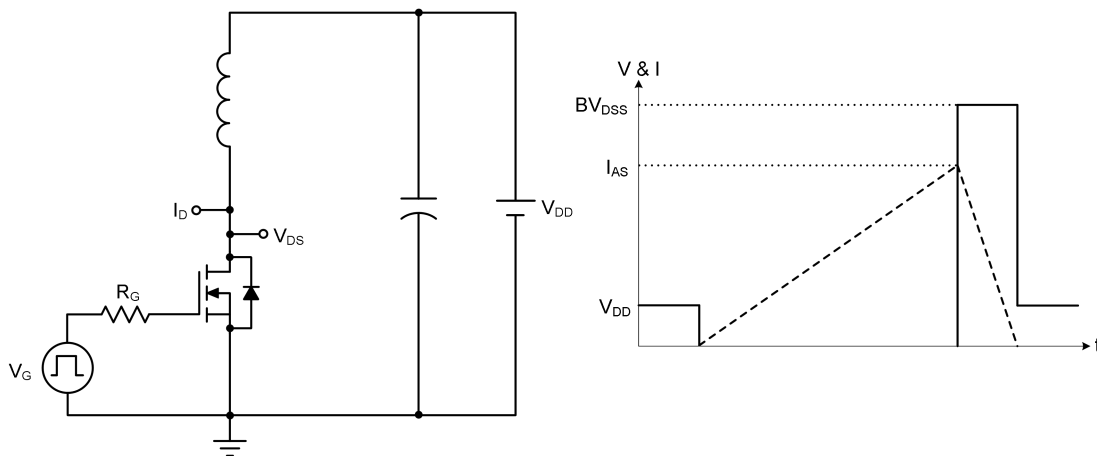

Figure 12. Transient Thermal Response Curve

Inductive Load Switching Test Circuit and Waveforms



Unclamped Inductive Switching Test Circuit & Waveforms



Peak Diode Recovery dv/dt Test Circuit and Waveforms

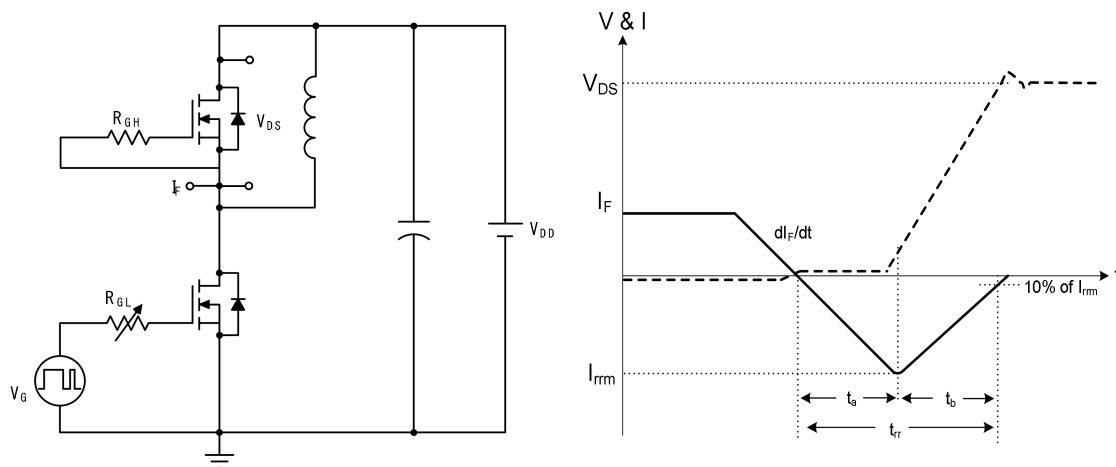

TO-263 OUTLINE

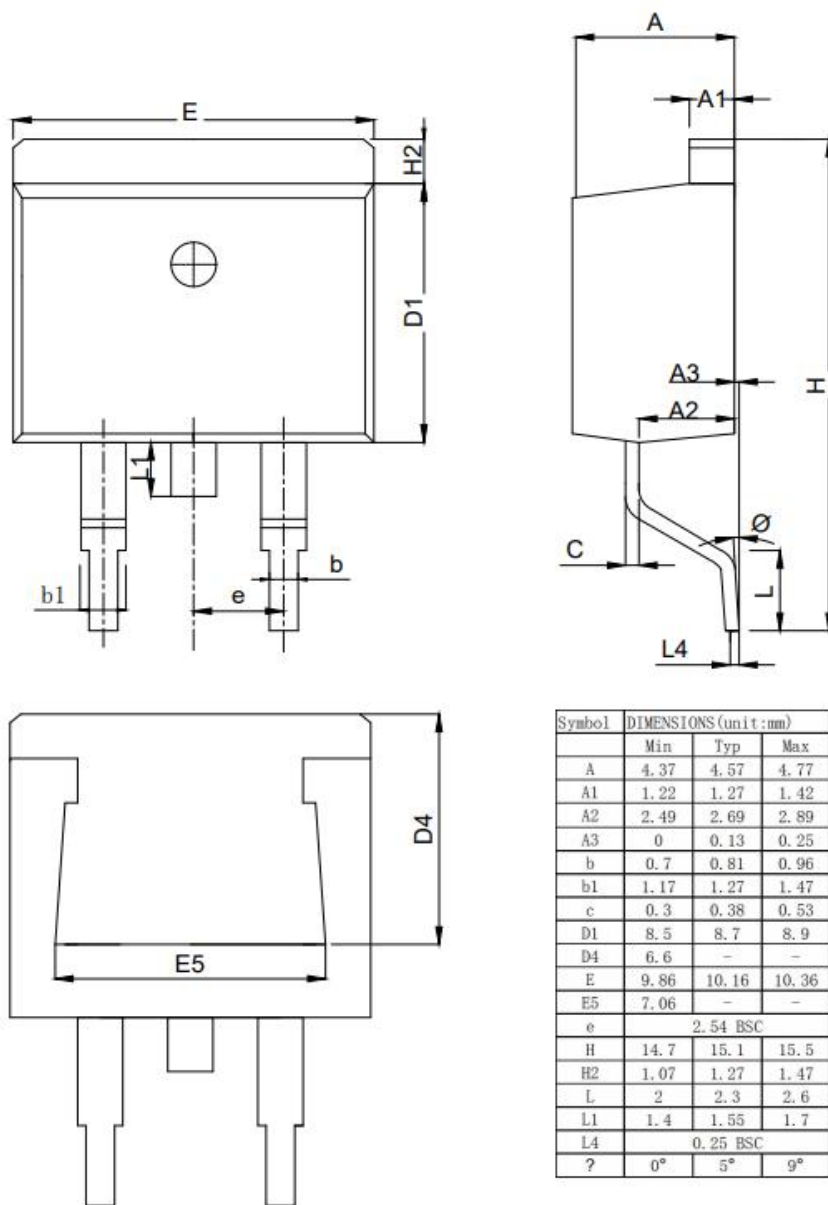

NOTE:

- 1.The plastic package is not marked as smooth surfaceRa=0.1;Subglossy surfaceRa=0.8
- 2.Undeclared tolerance ± 0.25 ,Unmarked filletRmax=0.25

Disclaimer

The content specified herein is for the purpose of introducing Msemitek's products (here in after "Products"). The information given in this document shall in no event be regarded as a guarantee of conditions or characteristics. Examples of application circuits, circuit constants and any other information contained herein illustrate the standard usage and operations of the Products. The peripheral conditions must be taken into account when designing circuits for mass production.

Msemitek does not assume any liability for infringement of patents, copyrights, or other intellectual property rights of third parties by or arising from the use of the Products or technical information described in this document.

The products are not designed or manufactured to be used with any equipment, device or system which requires an extremely high level of reliability the failure or malfunction of which may result in a direct threat to human life or create a risk of human injury (such as a medical instrument, transportation equipment, aerospace machinery, nuclear-reactor controller, fuel-controller or other safety device). Msemitek shall bear no responsibility in any way for use of any of the Products for the above special purposes.

Although, Msemitek endeavors to improve the quality and reliability of its products, semiconductor products have specific characteristics such as the occurrence of failure at a certain rate and malfunctions under certain use conditions. Please be sure to implement safety measures to guard them against the possibility of physical injury, and injury or damage caused by fire in the event of the failure of a Msemitek's product.

The content specified herein is subject to change for improvement without notice. When using a Msemitek's product, be sure to obtain the latest specifications.